



**UHC | Bb-Remote Transmission**

**MAGNETIC LEVEL GAUGE**

**Operating Manual**

UHC-Bb-DT-JS-1027-2018(A)



## PREFACE

Thank you for choosing the products of Dandong Top Electronics Instrument (Group)-Co.,Ltd. This operation manual provides you with important information on installation, connection and commissioning as well as on maintenance, troubleshooting and storage.

Please read it carefully before installation and commissioning and keep it as part of the product near the meter for easy reading.

This manual can be downloaded by entering the version number at [www.ddtop.com](http://www.ddtop.com).

If the instructions are not followed, the protection provided by the meter may be destroyed.

### Trademark, Copyright and Restriction Instructions

Dandong Top Electronics Instrument (Group) Co.,Ltd.®, Dandong Top Pump Co.,Ltd.®, DDTOP® are registered trademarks of the company.

The performance specifications of the meter are effective as of the date of publication and are subject to change without notice. Dandong Top Electronics Instrument (Group)Co.,Ltd. reserves the right to modify the products described in this manual at any time without prior notice.

### Quality Assurance

Dandong Top Electronics Instrument (Group) Co.,Ltd. guarantees that all variable area flow meters have no defects in materials and manufacturing processes within one year from the date of delivery. During the warranty period, if the product returns with quality problems and the claim is determined by the manufacturer to be within the scope of warranty, Dandong Top Electronics Instrument (Group) Co.,Ltd. is responsible for repair or replacement of the buyer (or owner) free of charge. Dandong Top Electronics Instrument (Group) Co.,Ltd. is not responsible for the costs caused by improper use of equipment, labor claims, direct or subsequent damage and installation and use of equipment. In addition to the special written warranty certificate for certain products of Dandong Top Electronics Instrument (Group) Co.,Ltd., Dandong Top Electronics

---

Instrument (Group) Co.,Ltd. does not provide any express or implied warranty.

## Quality

Dandong Top Electronics Instrument (Group) Co.,Ltd. has passed the ISO9001 quality system certification. The whole process of product production is strictly in accordance with the scope of the quality system, providing the strongest guarantee for product and service quality.

## Contents

1. Safety Tips .....	5
2. Product Descriptions .....	5
3. Technical Parameters .....	6
4. Outline Dimension Diagram .....	7
5. Unpacking and Inspection .....	8
6. Installation .....	8
7. Configuration .....	10
8. Precautions .....	15
9. Fault Analysis and Troubleshooting .....	16
10. Disassemble.....	16
11. Product Certification.....	16

## 1. Safety Tips

For safety reasons, it is expressly prohibited to modify or change the product without authorization. Repair or replacement is only allowed to use the accessories specified by the manufacturer.

### 1.1 The explosion may cause death or serious injury.

When installing the device in an explosive environment, be sure to comply with applicable local, national and international standards, codes and regulations. Ensure that the equipment is installed in accordance with intrinsically safe or non-flammable site operating procedures.

### 1.2 Process leakage may cause serious injury or death.

If the process seal is damaged, the medium may leak at the connection.

### 1.3 Failure to follow the safety installation guidelines may result in death or serious injury.

All operations described in this manual must be carried out by trained and qualified or end-user-appointed personnel.

## 2. Product Descriptions

### 2.1 Main Structure Figure 1-Remote Transmission

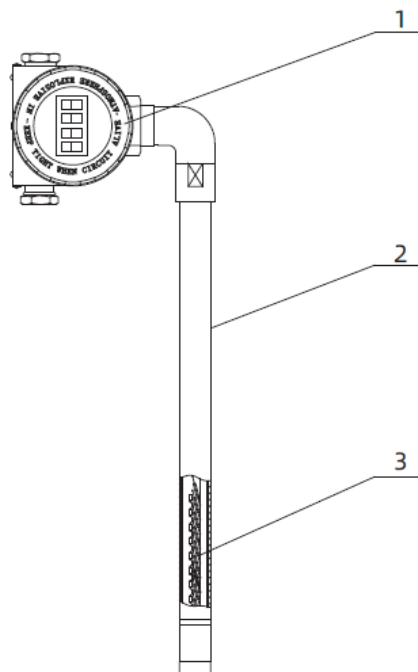

Figure 1 Product Constructure

1. Meter head assembly, converter circuit and LCD screen
2. Housing, protect the sensor circuit
3. Reed switch-resistance component, sensor circuit

## 2.2 Working Principle

The magnetic float in the measuring tube moves up and down with the fluid level or interface level of the medium, so that the resistance value in the sensor circuit changes linearly, and then the resistance value change is converted into a 4-20mA standard DC signal through the converter circuit in the meter head assembly. LCD display or output to the control room through the output terminal to achieve long-distance transmission of liquid level.

## 2.3 Packaging

Please take the packaging waste to a special recycling facility。

## 2.4 Lifting and Transportation

Please use quality lifting equipment and lifting straps, and pay attention to safety.

## 2.5 Storage

Storage temperature -20°C~40°C

Storage humidity ≤40%

## 3. Technical Parameters

### 3.1 Key Performance

3.1.1 The remote transmission device has passed the national explosion-proof certification

Certification mark: Intrinsically safe Ex ia II C T1 ~ T5/T6 Ga;

Flameproof Ex d II C T1 ~ T5/T6 Gb

3.1.2 Executive standard

GB/T 25153-2010 Magnetic level gauge for chemical pressure vessel

JB/T 12957-2016 Magnetic level gauge

### 3.2 Main Parameters

Measuring Range	0~6000mm (> 6000mm special customized)
Power Supply	24V DC
Output	4~20mA DC (with HART)
Load Characteristics	See load characteristics chart (Figure 2)
Ambient Temperature	-40°C~+80°C
Working Temperature	-40°C~+200°C (When T≥150°C, the transmitter does not allow heat preservation)
Accuracy	±5mm
Power Inlet	M20×1.5(female thread) or as customer requirement
Explosion-proof Type	Intrinsically safe Ex ia II C T1 ~ T5/T6 Ga Flameproof Ex d II C T1 ~ T5/T6 Gb
Ingress Protection	IP66

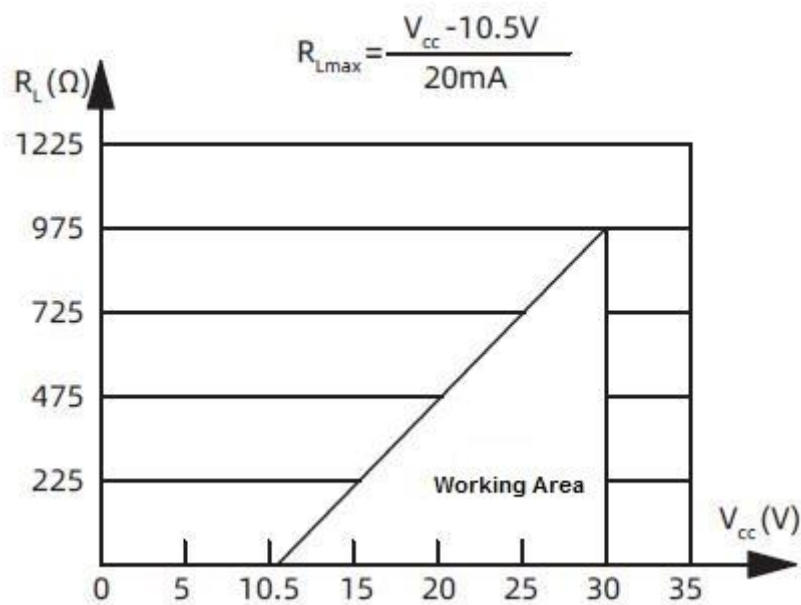

Figure 2 Load Characteristic Diagram

### 4. Outline Dimension Diagram

If special size is required when ordering, the actual size shall prevail.

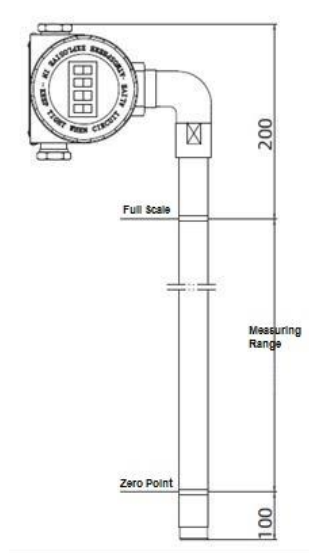

Figure 3 Remote Transmission Device

## 5. Unpacking and Inspection

### 5.1 Precautions for unpacking inspection

5.1.1 Check whether the product nameplate is consistent with the packing list information Figure 4

		<b>UHC-Bb Transmitter</b>	
		10F211-21	
<b>Explos ion-proof</b>	Exia II CT1~T5/T6 Ga Exd II CT1~T5/T6 Gb	<b>Power Supply</b> 24V DC	<b>Range</b> mm
		<b>Output</b> 4~20mA	<b>Ingress Protection</b> IP66
		<b>Tag No</b>	<b>Manufacturer Date/No.</b>
Dandong Top Electronics Instrument (Group) Co.,Ltd			

Figure 4 Product Nameplate

5.1.2 Check the quantity and material of each part against the packing list.

### 5.2 Content of Inspection

Check the appearance of the instrument for defects, damage and other abnormalities

## 6. Installation

### 6.1 Installation Tools

Hose clamp, screwdriver



## 6.2 Installation and operation process - Figure 5

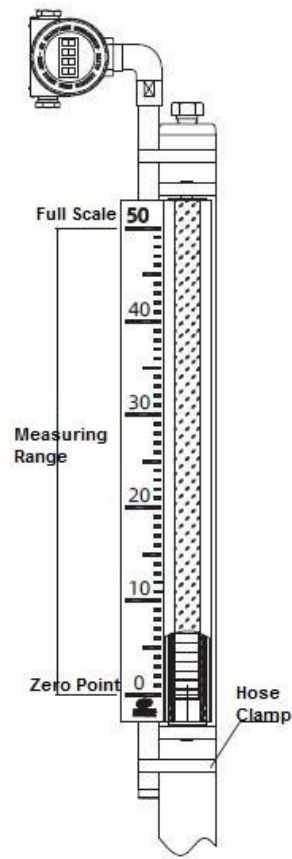

Figure 5 Installation

6.2.1 When installing the remote transmission device, as shown in Figure 5, the zero point full scale of the remote transmission device (marked at the factory) and the 0 scale full scale of the on-site indicator on the measuring tube are one-to-one correspondence, and then fixed with a hose clamp.

6.2.2 Remote transmission device wiring: after removing the cover, you can connect according to the wiring diagram in Figure 6

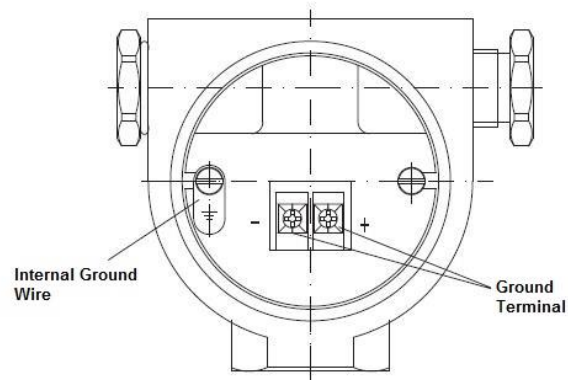

Figure 6 Transmitter Wiring Diagram

## 7. Configuration

### 7.1 Transmitter Configuration

This section mainly introduces how to use the 3 local keys (Enter key ← ), (up key " ↑ "), (down key " ↓ "), combined with LCD display to configure internal parameters.

#### 7.1.1 LCD display function overview

See (Figure 7-1) for full screen information. The variables that can be displayed on the LCD screen include current (Figure 7-2), percentage (Figure 7-3) and main variable (Figure 7-4). You can set to display a single variable, or you can set the percentage and the main variable to cycle display, and the effective digits of the decimal part can be set (0, 1, 2, 3, 4 decimal places). The display mode is set by 475 configuration software or button. If the percentage and main variable are set to be displayed cyclically, the LCD will display these two variables alternately with a period of 3 seconds.

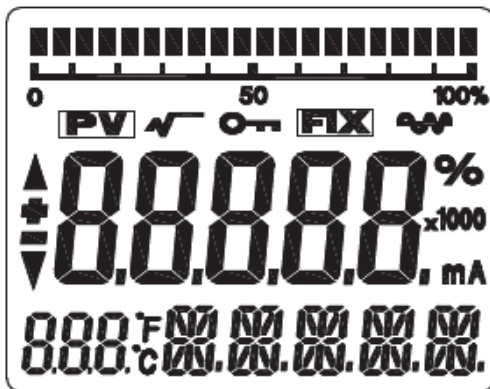

Figure 7-1 Full LCD display

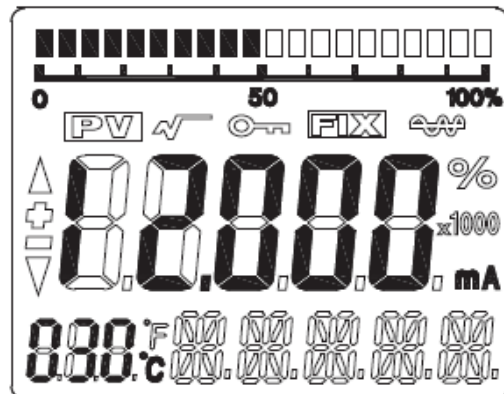

Figure 7-2 Current display

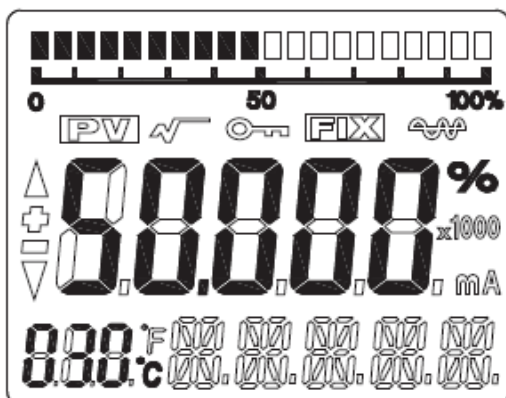

Figure 7-3 Percentage display

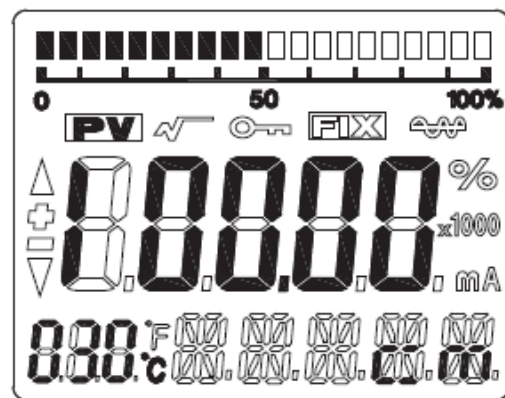







Figure 7-4 Main variable display



#### 7.1.2 LCD Display Symbol Description

① If it is in HART communication status, the symbol  on the right corner of the LCD screen will flash.

- ② If it is in root output, the LCD will display .
- ③ If a fixed output current is set, the LCD will display **FIX**.
- ④ If the write protection is activated, the LCD will display .
- ⑤ The three "888" display bits in the lower left corner of the LCD display the temperature of the electronic module and the menu number during configuration.

### 7.1.3 Button function description



There are a total of three buttons on the LCD panel. The three buttons are the enter key "", the down key "", and the up key ".

- The " " and " " keys are used to prompt the increase or decrease of data bits and the shift of the decimal point;
- The " " key is used to enter the prompt data setting interface and save the data.



### 7.1.4 Description of parameter configuration

Long press "". When the "888" character in the lower left corner shows 1 ~ 17, it indicates that the transmitter is in the field configuration mode with menu rotation. At this time, you can input the initialization code, modify the parameters, calibrate the instrument or perform migration by pressing.

The data setting process utilizes:

- The " " key is used to select the digit and decimal point to be edited and confirm the final save.  
(Flashing is selected)
- The " " key is used to increase the flashing digits to cycle from 0-9 and move the decimal point to the right.
- The " " key is used to decrement the flashing digits to cycle from 9-0 and move the decimal point to the left.

The setting process is as follows:

(1) Long press the " " key to enter the data configuration interface. At this time, the lower left corner displays '01', and the data line displays '00005'. When the " " key is pressed again, the symbol bit starts to flash, indicating that the symbol can be modified Bit.

- (2) If you press the '↑' key or '↓' again, you can switch the sign of the data.
- (3) Press the '←' key again, the symbol is selected and the first digit starts to flash, indicating that it can be modified. Press for a long time or repeatedly press the '↑' key or '↓' to set the number between 0-9 between cycles.
- (4) Press the '←' key again, the first digit is set and the second to fifth digits can be set in sequence at the same time. The setting method is exactly the same as the first digit.
- (5) After setting the fifth digit, press '←' to start setting the decimal point. The decimal point starts to flash at the same time, indicating that the decimal point can be set. At this time, press the '↑' key or '↓' to move the position of the decimal point to the right or left to cycle through.
- (6) After the decimal point is set, press the '←' key, the up and down arrows on the left will light up, indicating that the setting is saved.
- (7) Press '←' again to restart setting data.

#### 7.1.5 Key function code quick reference table

When using button configuration on site, the two "888" display characters in the lower left corner of the LCD indicate the current setting menu number, which is the setting function performed by the current button. The corresponding relationship is:

"888" display in the lower left corner	Set variable
0 or empty	Normal Display
1	Enter the operation code (00911 initialize the meter)
2	Set unit
3	Set the lower limit of the range LRV
4	Set the upper limit URV
5	Set damping time
8	Density (standby)
9	Any point migration input compensation value, compensation value = P actual measurement - P pre-output
11	LRV calibration
12	URV calibration
17	View sensor value

The instrument calibration, upper and lower limits of range and damping setting can be completed according to the description in 7.1.4 Data Setting Method"

#### 7.1.6 Unit Setup

The units that can be set are: m, cm, mm, feet, and inch.

- ① Long press the '←' key to enter the configuration mode (first menu No. 1 is displayed, the up and down arrows on the left are lit).
- ② Press the "↑" key to switch the menu to No. 2, and the current unit symbol is displayed in the lower right corner.
- ③ Press the "←" key again, and the unit starts to blink. At this time, press the '↑' key or '↓' to switch to the unit you want to set.
- ④ Press the "←" key again, the unit setting is completed and the up and down arrows on the left will light up.

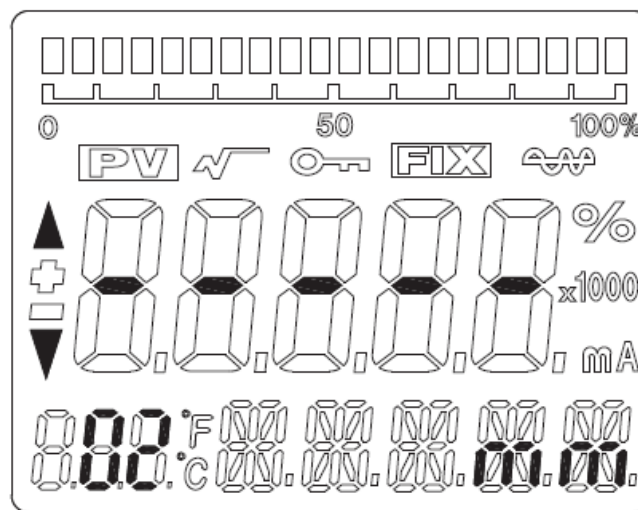

Unit Setup

### 7.1.7 Range setting

Set the lower limit of the range LRV.

- ① Long press the '←' key to enter the configuration mode (first menu No. 1 is displayed, the up and down arrows on the left are lit)
- ② Press the "↑" key to switch the menu to No. 3, and the LCD will display the current LRV value.
- ③ Press the "←" key again, and the symbol starts to flash. At this time, press the '↑' key or '↓' to switch to the sign you want to set.
- ④ Press the "←" key to complete the symbol setting and start to set the highest digit of the range. At this time, press the "↑" key or "↓" to increase or decrease the current flashing digit and press the "←" key confirm, set other digits and decimal points in sequence, and the

menu item setting is completed when the up and down arrows on the left light up.

Set the upper limit URV

Switch the menu to No. 4, and the LCD displays the current URV value at the same time, and then repeat the steps ③ and ④ in 7.1.6 to set.

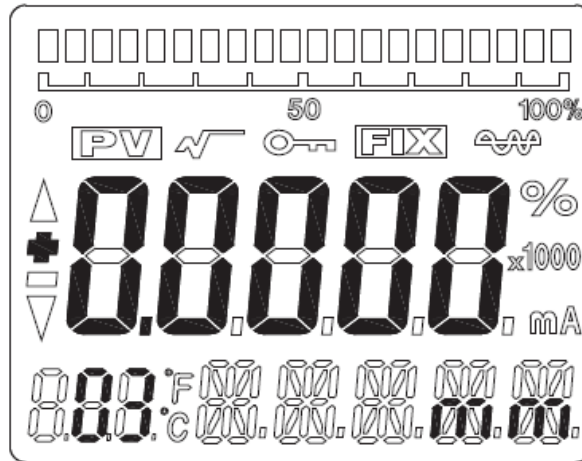

Range Setting

#### 7.1.8 Damping setting

Switch the menu to No. 5, and the LCD will display the current damping value at the same time, and then repeat the steps ③ and ④ in 7.1.6 to set until the completion.

#### 7.1.9 Two-point calibration

LRV calibration

- ① First adjust the PV value to the zero position (Move the magnetic float to zero)
- ② Switch the menu to No. 11, and the LCD will display the current calibration position value at the same time, and then repeat ③④ in 7.1.6 to input the zero point value for zero point position calibration.
- ③ Press the "←" key until the up and down arrows on the left light up the zero position calibration is completed

URV calibration

- ② First adjust the PV value to the full-scale position (Move the magnetic float to zero)
- ③ Switch the menu to No. 12, and the LCD will display the current calibration position value at the same time, and then repeat ③④ in 7.1.6 to input the full scale value for full scale position calibration

③ Press the "←" key until the up and down arrows on the left light up the full scale position calibration is completed

#### 7.1.10 Move at any point

Menu '9' can realize any point migration function. The user can migrate the current PV value to any point within the range. (Enter compensation value) The setting process is as follows:

- ① Long press the '←' key to enter the configuration mode (first menu No. 1 is displayed, the up and down arrows on the left are lit)
- ② Press the "↑" key to switch the menu to '9' and the LCD will display the current PV compensation value
- ③ Press the "←" key again, and the symbol starts to flash. At this time, press the '↑' key or '↓' to switch to the sign you want to set.
- ④ Press the "←" key to complete the symbol setting, and at the same time the highest digit of the parameter to be set starts to flash. At this time, press the '↑' key or '↓' to increase or decrease the current flashing digit, and press the "←" key to confirm and start the next digit setting, and set other digits and decimal points in sequence. When the up and down arrows on the left side light up, the menu function setting is complete.

Compensation value calculation method:

Compensation value = PV actual measurement - PV pre-output

Note: The key configuration process will not automatically exit and it is needed to manually exit the key configuration. The method is to continuously press the '↑' key or '↓' key in the switching menu state to increase or decrease the menu. When the menu is greater than 17 or less than 1, exit the button configuration state and enter the normal output mode.

## 8. Precautions

- 8.1 For the remote transmission device with heat insulation pad, the heat insulation pad should be placed between the remote transmission device and the measuring tube during installation;
- 8.2 When the temperature is  $\geq 150^{\circ}\text{C}$ , it cannot be kept together with the remote transmission device during heat preservation;
- 8.3 Make sure that the power supply is safe and reliable, and the power supply should be connected in accordance with the correct positive and negative poles;

- 8.4 The remote transmission device is not suitable to work in a strong magnetic field other than the magnetic field of the magnetic float;
- 8.5 After configuration, tighten the display and power cover to prevent the meter from getting wet.

## 9. Fault Analysis and Troubleshooting

Failure Phenomenon	Cause Analysis	Troubleshooting method
The remote transmission device has no signal output or inaccurate output	<ul style="list-style-type: none"> <li>1. The remote transmission device has no power signal input</li> <li>2. The components in the remote transmission device circuit detection board are damaged</li> </ul>	<ul style="list-style-type: none"> <li>1. Turn on the power</li> <li>2. Replace the circuit detection board</li> </ul>

## 10. Disassemble

### 10.1 Warning

Before disassembling, pay attention to dangerous process conditions, such as pressure, high temperature, corrosive or toxic media in the container, etc.







Please refer to the instructions in the chapter 6.2 Installation Operation Process and 7.1 Electrical Wiring, and remove the components in the reverse order of the operation steps.

### 10.2 Waste Removal

Please follow the current regulations in each region for waste disposal.

## 11. Product Certification



Product Certification			
Certification		Certification No.	Certification Scope
PED		DGR-0036-QS-1217-19	Directive 2014/68/EU Annex III, Module H1
ATEX		Sira 19ATEX1146X	II 1G Ex ia IIC T5/T6Ga Ta = -40°C to 60°C  II 2G Ex db IIC T4...T6 Gb Ta = -40°C to 50°C/60°C/70°C
IECEX		IECEX SIR 19.0049X	Ex db IIC T4...T6 Gb Ex ia IIC T5/T6 Ga Ta = -40°C to 60°C for Ex ia Ta = -40°C to 50°C/60°C/70°C for Ex db
EMC		AE 50464663 0001	
Explosion-proof		CCRI 17.2056X CCRI 17.1001X	Ex ia IIC T5/T6 Ga Ex d IIC T1~T5/T6 Gb
CCS Certification		DL17T0006_02	Ships and Mobile Offshore Units
Type Approval Certificate		10F211-21	